



ElhandHF™  
**Harmonic Filters**

---

for Oil&Gas applications



# ELHAND Passive Harmonic Filters



**ElhandHF™ Harmonic Filter** allows to utilize system power capacity to maximum degree, protects equipment from malfunction and extends system run life. Compensation of harmonics by filter application helps to comply with IEEE 519, EN-61000-3 or other energy quality standards. Harmonic Filter saves electricity, lowers system cost, and increases investment return.

## Elhand Harmonic Filter Application

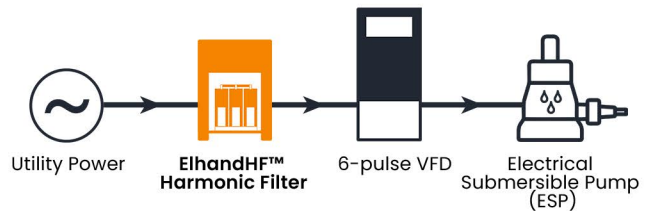

## Elhand Harmonic Filter Performance

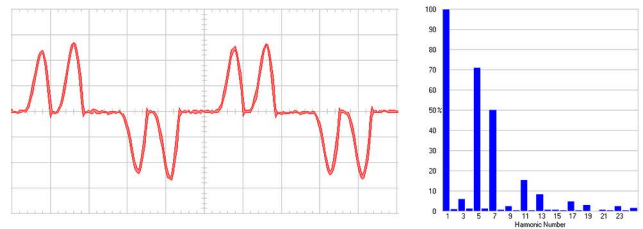

Without ElhandHF™ Harmonic Filter

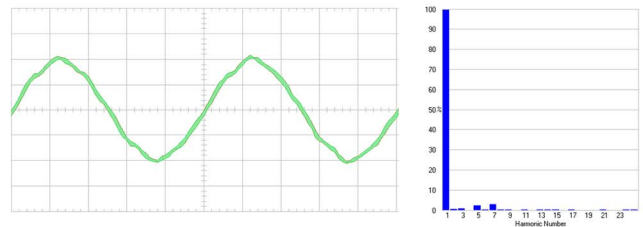

With ElhandHF™ Harmonic Filter

Approvals:



## Technical data

- Rated power:	2,2 kW (3 HP) – 2600 kW (3500 HP)
- Rated Voltage:	380, 400, 415, 480, 500, 600, 690 V
- Rated frequency:	50 Hz, 60 Hz
- THDi:	≤5% according to IEEE 519
- Overload capability:	110% P <sub>n</sub> (continuous) 160% P <sub>n</sub> 1 min/h (momentary)
- Capacitive power consumption at no load:	≤15% of rated power for filters from 132 kW (175 HP) to 2600 kW (3500 HP) ≤20% of rated power for filters from 2,2 kW (3 HP) to 110 kW (150 HP)
- Ambient temperature:	40°C – land design 45°C – maritime / tropical ≥50°C – heavy duty design
- Insulation class:	F ≤ 75 kW; H ≥ 90 kW (120HP)
- Winding material:	Cu ≤ 110 kW (150HP) Al ≥ 75 kW (100 HP)
- Standard equipment:	NC temperature switch, other on request
- Mounting:	wall-mounted or floor-mounted
- Degree of protection:	IP00, IP23, IP54, IP66 Open type, NEMA 3/3R, NEMA 4/4X
- Standards compatibility:	IEC 60076-6



ELHAND TRANSFORMATORY Sp. z o.o.  
ul. Klonowa 60; 42-700 Lubliniec;  
Poland



+48 (34) 34 73 100  
fax +48 (34) 34 70 207



info@elhand.com  
www.elhand.com

# Release The Power Of Your Diesel Generator

ELHAND Harmonic Filters are designed to provide high quality current with minimum capacitive power.

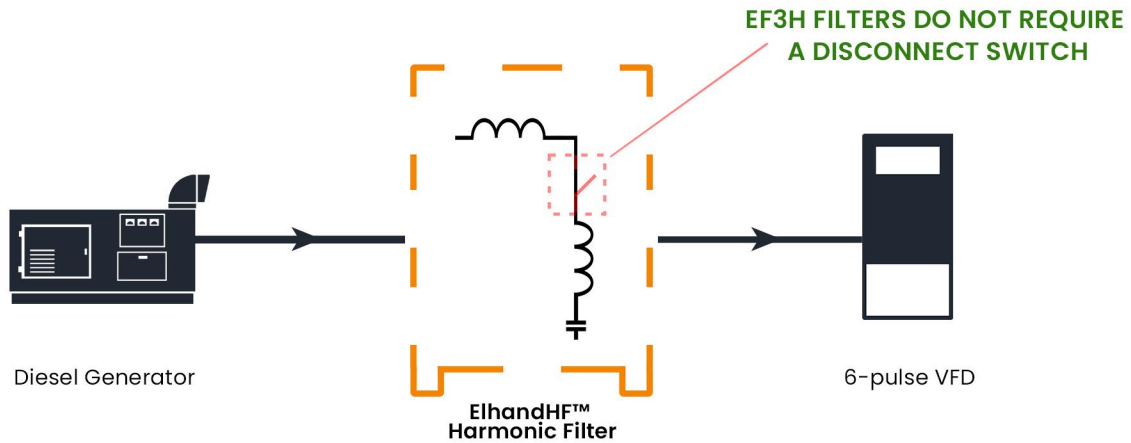

$$\leq 0,06 \text{ kvar/HP}$$

The ratio of capacitive power to the drive power is safe for generators. This allows the drive system equipped with Elhand harmonic filter to be powered directly from the generator without the need for disconnecting the capacitor bank.

## Benefits of Elhand filters:

- Compatibility with diesel generators at low loads, without contactors
- Reduced power losses in the system and fuel consumption of generator
- High power factor
- Low THDi and compatibility with IEEE 519
- Easy integration, minimum assembly work

## ELHAND vs. Competitors

HARMONIC FILTER POWER FACTOR

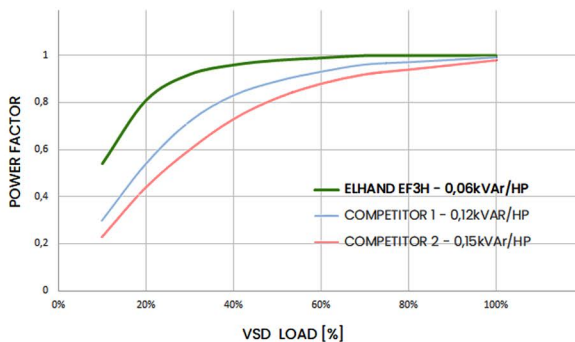

HARMONIC FILTER INPUT CURRENT

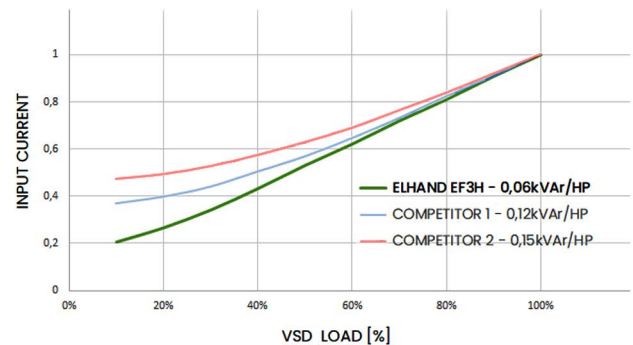

Oil extraction systems (ESP) rarely operate continuously at full load. Much depends on reservoir properties and conditions at the extraction site. That is why it is crucial to ensure a sufficiently high power factor for a wide range of drive loads. Elhand EF3H filters provide a very high power factor across a wide range of drive loads. This directly translates into lower input current of our filters at partial drive loads compared to competitor filters. It results in tangible energy savings and increases the lifespan of the entire drive system.



ELHAND TRANSFORMATORY Sp. z o.o.  
ul. Klonowa 60; 42-700 Lubliniec;  
Poland



+48 (34) 34 73 100  
fax +48 (34) 34 70 207



info@elhand.com  
www.elhand.com





## Elhand Power Quality Harmonic Simulation Software (EPQ)

We understand how challenging it is to select and optimize magnetic components in a specific drive system. That is why we provide dedicated software for all people whose task is to compare and evaluate the performance and impact of drive applications on the power grid and other system components. EPQ Software is for free.

Elhand Power Quality Harmonic Simulation Software – is a unique simulation program, designed to calculate the level of voltage and current distortions in the network with any structure of power supply and loads. The application allows to solve problems with distortions and harmonics, and to quickly and

accurately analyse the parameters of the entire power system. It takes into account the negative impact of non-linear loads on the power grid and its parameters at the point of common coupling. EPQ also helps in the selection and optimization of magnetic elements (transformers, reactors, filters).

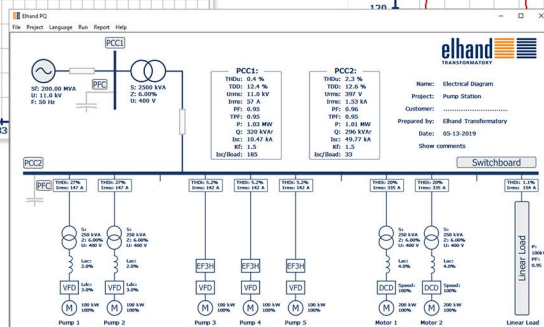
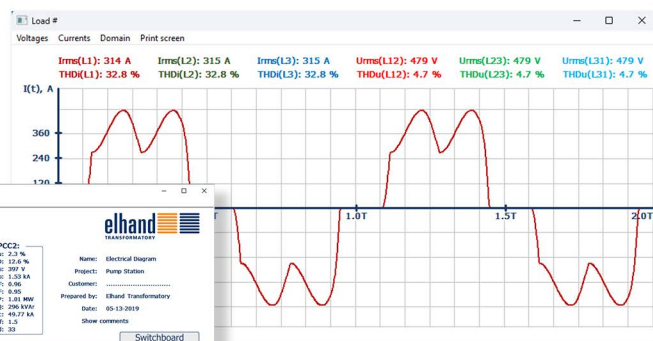
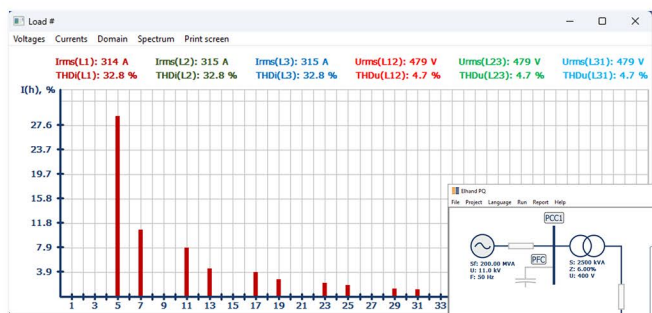

ELHAND TRANSFORMATORY Sp. z o.o.  
ul. Klonowa 60; 42-700 Lubliniec;  
Poland



+48 (34) 34 73 100  
fax +48 (34) 34 70 207



info@elhand.com  
www.elhand.com